

# FORD TRUCK

$\frac{1}{4}$  TON 4 x 4  
MODEL GPW

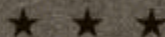

## INSTRUCTIONS FOR UNPACKING & ASSEMBLY OF BOXED VEHICLE



Fully Sheathed Crate

*Ford Motor Company*

DEARBORN,

MICHIGAN.

## **FOREWORD**

This Motor Vehicle has been thoroughly tested and inspected before being packed for shipment. Like any other piece of machinery, to maintain it in proper operating condition, it should be lubricated and receive periodic systematic inspection as outlined in TM 9-803 Technical Manual which is furnished with each vehicle.

The following pages outline how to remove the vehicle from the packing case and the sequence of operations necessary in the assembly.

**FORD MOTOR COMPANY**

**Dearborn, Mich., U. S. A.**



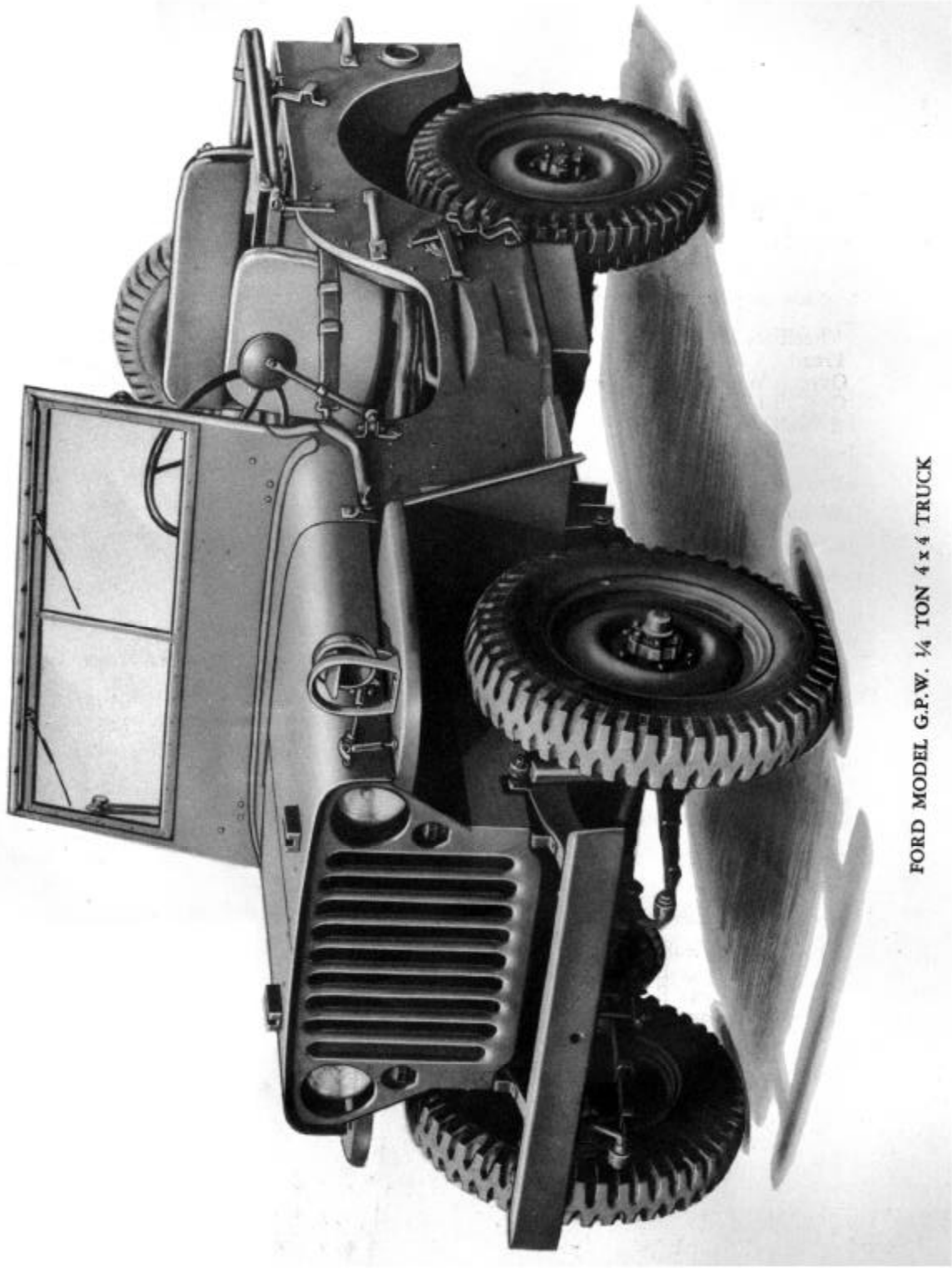

FORD MODEL G.P.W. 1/4 TON 4x4 TRUCK

# INSTRUCTIONS FOR UNCRATING AND ASSEMBLY OF VEHICLE

## Uncrating Vehicle

Before the vehicle is packed in the crate, certain parts and assemblies are removed from the chassis and body in order to reduce the cubic contents as much as possible.

The parts or assemblies removed are securely strapped in place or packed in boxes fastened to the bottom of the crate.

To open the crate, remove nails from the metal band around top edge of crate.

Remove weather-proof paper and pull nails from metal bands over top on each end of the crate (fig. 2).

Pull spikes from side panel to the three joists on inside of top panel; also the nails from top cover panel to side and end panels.

The top cover can now be removed as one unit.

## Packing Sheets

Remove the packing sheets and Instructions for Unpacking and Assembly Book from the envelope which is attached to the inside of the crate.

Remove the outside corner metal bands and the spikes through the corners of the crate (fig. 2), also the nails around the bottom of the side and end panels. Remove the side and end panels.

When all parts and assemblies have been removed from the individual packing boxes, and accessories from tool compartments located in the right and left rear corners of the body, check the parts according to the packing sheet list. Boxes are numbered 1, 2, 3, etc.

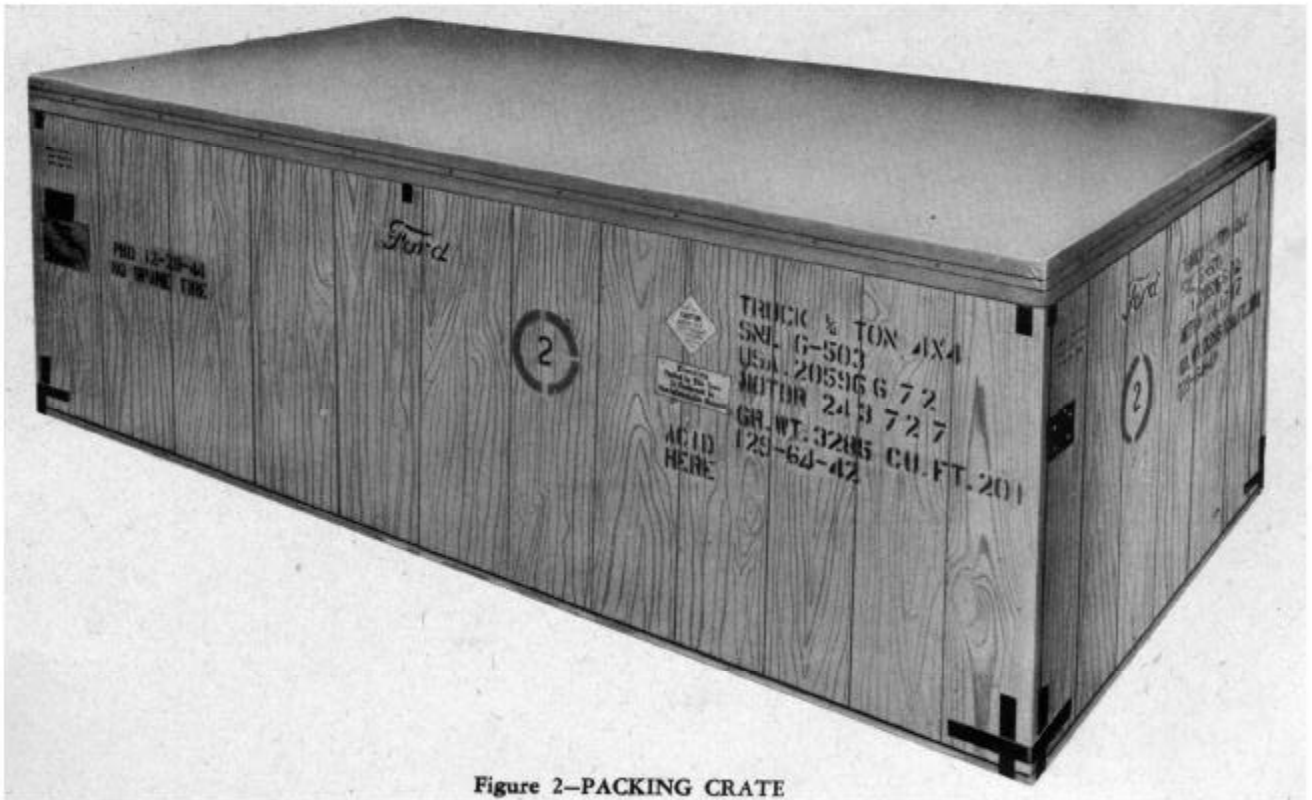

Figure 2—PACKING CRATE

## Removal of Vehicle from Crate

Remove metal straps holding wheels in place, and remove the five wheels from inside of body.

Remove canvas top, side curtains from under passenger seat.

Remove chassis rear hold-down strap bolts and nuts (No. 1, fig. 3) from the rear cross joist on crate flooring, also the bolts and nuts from frame rear cross member.

Cut the metal band (No. 2, fig. 3) from around rear shock absorbers.

Raise rear end of vehicle about 2 feet which will release the strain on chassis front hold-down straps.

Remove the hold-down strap bolts and nuts (No. 1, fig. 4) from the front cross joist on the crate flooring and slide the straps off the front bumper.

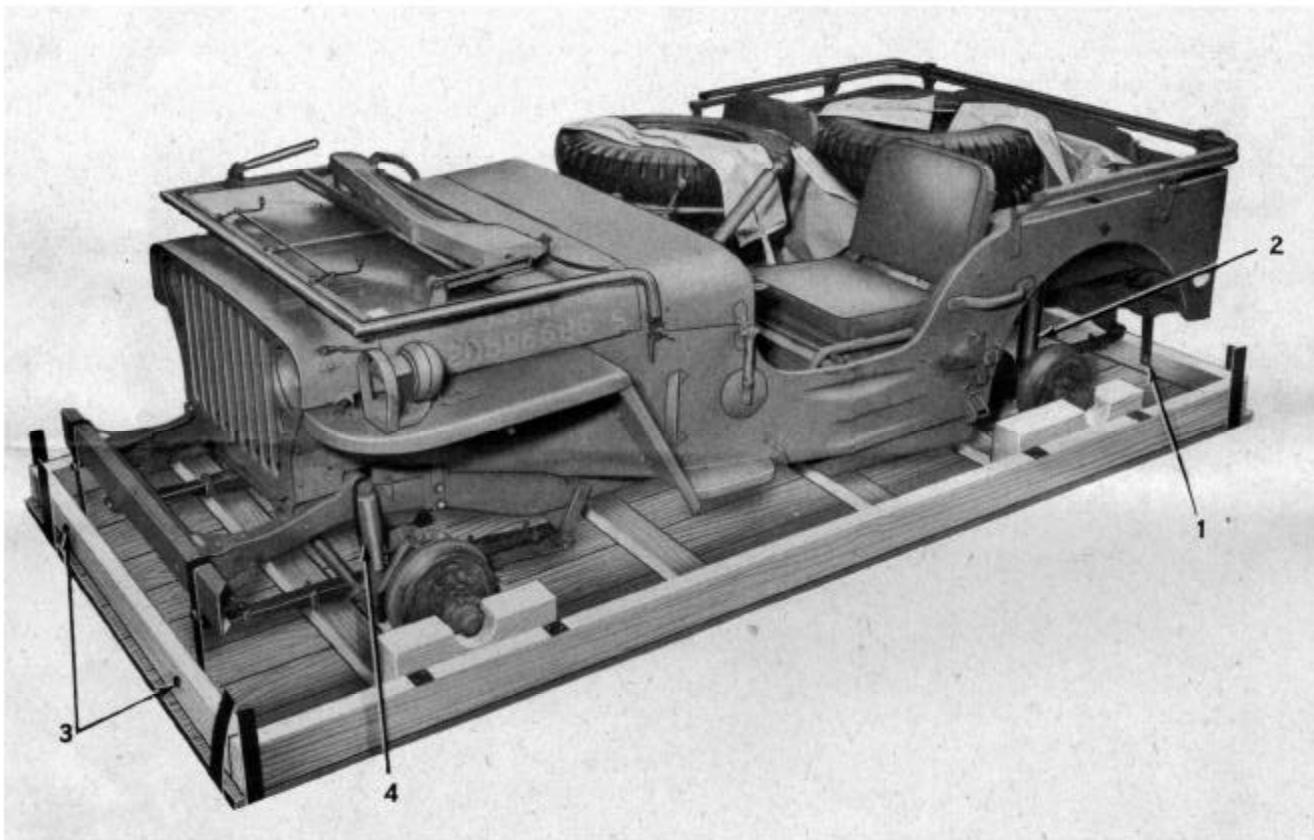

Figure 3—PACKING CRATE WITH TOP AND SIDES REMOVED (LEFT SIDE)

Cut the metal band (No. 2, fig. 4) from around front shock absorbers.

Install rear wheels (wheel nuts are in place on hub bolts). Left-hand threaded nuts (marked "L") are used on wheel hub bolts on left side of vehicle.

Remove battery acid container (No. 3, fig. 4).

Raise front of vehicle and install front wheels. (Wheel nuts are in place on hub bolts.)

Remove vehicle from crate.

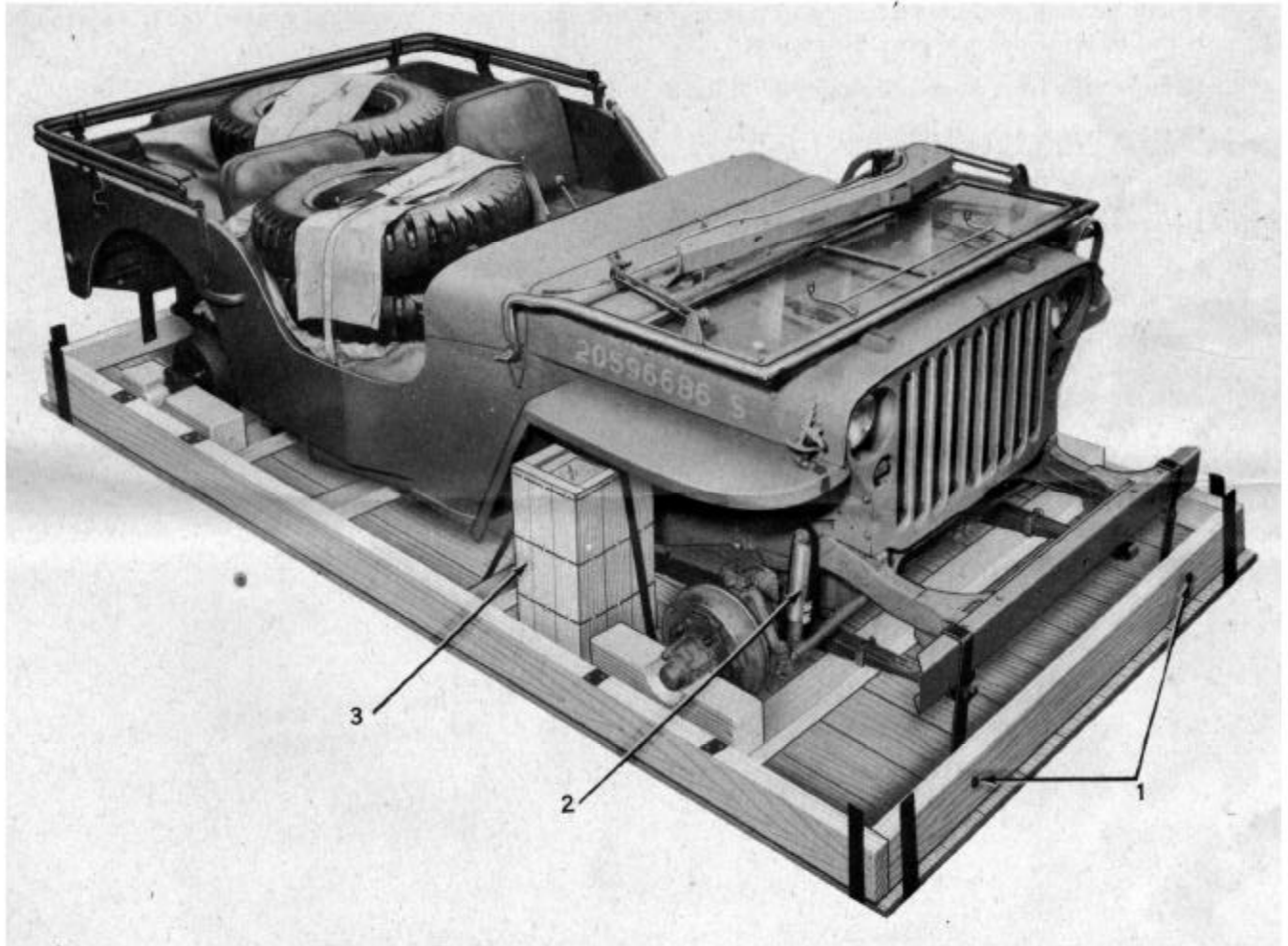

Figure 4—PACKING CRATE WITH TOP AND SIDES REMOVED (RIGHT SIDE)

## Assembly

Install rear outside body handles, No. 1, fig. 5 (bolts and nuts are on handles).

Install spare wheel carrier to back of body, (No. 2, fig. 5) (bolts and nuts are in place on carrier).

Install rear bumperettes, No. 3, fig. 5 (attaching bolts and nuts are on bumperettes).

Install pintle hook on rear cross member, No. 4, fig. 5. The backing plate goes inside of frame (bolts and nuts are on pintle hook).

Install spare fuel container bracket (bolts are in bracket), No. 5, fig. 5.

Set front wheels in straight ahead position by placing a straight edge from rear wheel to front wheel so that it touches the tires at front and rear of each wheel.

Install steering wheel to steering post tube so that one spoke points downward toward driver's seat and is in line with steering post. No. 6, fig. 5.

Remove tape from horn opening, No. 1, fig. 6.

Remove block located under toe board which holds clutch depressed.

Remove tape from generator openings.

Remove tape from water pump.

## Prepare Vehicle for Operation

Remove tape from the following units: air cleaner, No. 2, fig. 6; oil filler tube, No. 3, fig. 6; distributor, No. 4, fig. 6; engine ventilator tube, No. 5, fig. 6; battery filler caps, muffler tail pipe, radiator cap and radiator overflow pipe.

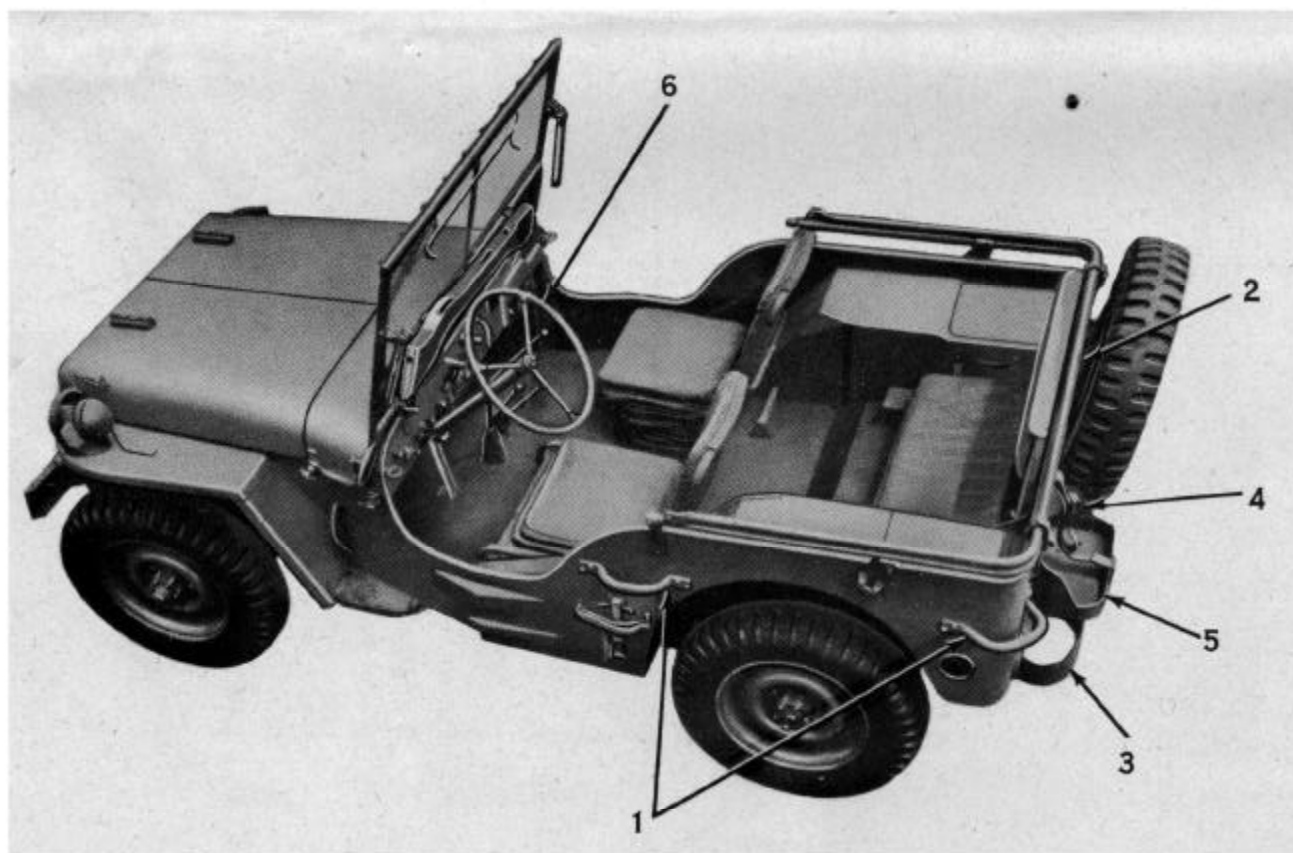

Figure 5—ASSEMBLY PROCEDURE



All bonds and bond connections must be clean.

Connect starter cable to large battery post and ground cable to small battery post.

Remove air cleaner, No. 6, fig. 6, by removing the two wing nuts, No. 7, fig. 6, loosen the two wing nuts on other side. Swing assembly toward radiator so as to clear studs and out toward right front fender, then slide assembly off studs.

To remove the air cleaner base from cover assembly use a wood block or a hammer handle inserted through top and tap sharply on base. Place one pint of engine oil of the specified grade in base, place cover assembly over base and press down, locking cover to base. Install assembly to brackets on dash.

Fill radiator, No. 8, fig. 6, with water, capacity 11 quarts. Use anti-freeze if necessary.

Fill engine with 4 quarts of engine oil through oil filler tube, No. 3, fig. 6.

Fill fuel tank through filler opening under driver's seat cushion. Replace cap, turning it to located position. Prime carburetor by operating the priming lever (located on rear side of the fuel pump body) up and down. This operates the fuel pump diaphragm manually and pumps the fuel from the fuel tank, filling the filter and carburetor bowl.

Turn rear view mirror up to position.

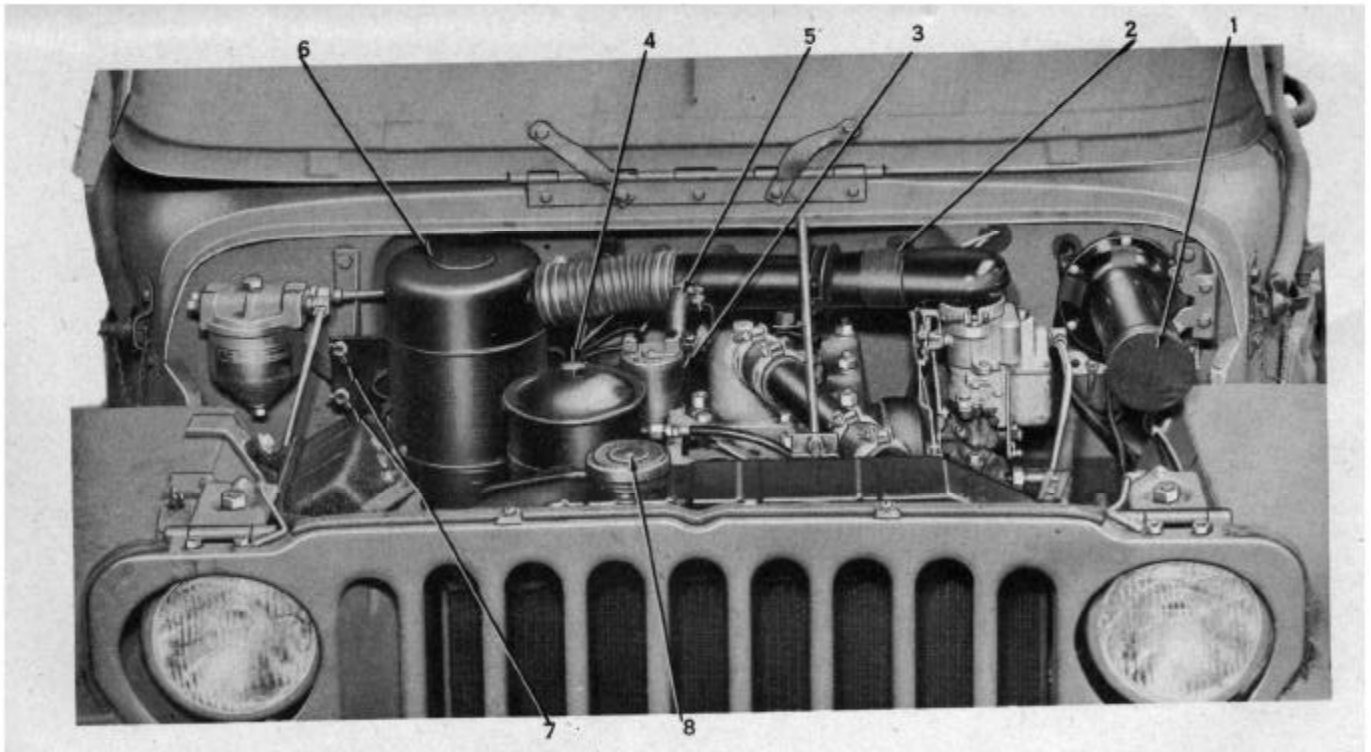

Figure 6—ENGINE COMPARTMENT



## To Prepare Battery for Use

Dry-charged Storage Battery Type 17B-8811-2H (U. S. Army Specif.).

This battery is shipped with the plates in a partly charged condition. The vent plugs must be left tightly in place until ready to fill the battery.

The electrolyte to use for filling is dilute sulphuric acid. It must be pure and suitable for storage battery use and of proper specific gravity. (See table.) The temperature of the filling electrolyte should not exceed 90° Fahrenheit (32° Centigrade).

|                          | <i>Temperate<br/>Climate</i> | <i>Tropical*<br/>Climate</i> |
|--------------------------|------------------------------|------------------------------|
| Filling Gravity.....     | 1.260.....                   | 1.210                        |
| Maximum Temperature..... | 110°F.....                   | 125°F.                       |
| Final Gravity.....       | 1.270-1.285.....             | 1.200-1.220                  |

\*A tropical climate is one in which water never freezes.

## To Prepare Battery for Service

1. Unscrew vent plugs. Remove temporary paper discs from filling holes and discard them.
  2. Fill each cell with the prepared electrolyte to  $\frac{3}{8}$  inch above top of separators.
  3. Allow the battery to stand at least one hour after filling with electrolyte. If level has fallen, add electrolyte to restore it. Replace vent plugs in cells. If any electrolyte was spilled on battery, it should be removed by means of a cloth slightly dampened with a weak solution of baking soda and water.
  4. A freshening charge at 8 amperes should be given before placing in service. Make certain the positive terminal of battery (marked POS or + or painted red) is connected to the positive of the charge circuit, and negative terminal of battery (marked NEG or — or painted black) is connected to negative of charge circuit.
  5. Charge until four consecutive hourly readings show no rise in specific gravity for the lowest cell. If above rate is maintained, length of charging time will be at least 12 hours; lower rates will increase the time proportionately. If necessary to restore electrolyte level during charge, use only approved water.
  6. After completion of charge, the gravity should be shown in table, corrected to 77° Fahrenheit and with the level  $\frac{3}{8}$  inch above top of separators. If it is not, adjust by removing some solution and replacing with approved water or electrolyte as required. Charge the battery to mix solution before testing again.
- NOTE: See battery manufacturer's special instructions on battery.

This vehicle should be serviced in accordance with instructions given in Technical Manual TM 9-803, paragraph 13, page 29, before being placed in operation.



